

QUICK START GUIDE

MC664 | MC664-X

P861 | P862

SAFETY WARNING

During the installation or use of control systems, users of Trio products must ensure that there is no possibility of injury to any person or damage to machinery.

Control systems, especially during installation, can malfunction or behave unexpectedly. Bearing this in mind, users must ensure that even in the event of a malfunction or unexpected behaviour, the safety of an operator or programmer is never compromised.

MC664(X) FEATURE SUMMARY

	MC664	MC664-X
Processor	ARM A9 Single Core	ARM A9 Quad Core
Servo update rate	125 to 4000 usecs	50 to 4000 usecs
Maximum axes	64	128
Absolute encoder support	Yes	Yes
EtherCAT axes included (1)	0	2
EtherCAT registration (2)	Inputs 0 to 7	Inputs 0 to 7
Firmware recovery mode	Yes	Yes
Non-volatile memory		
VR store	Flash	Flash
Table (1st 196k)	Flash	Flash
Real time clock	Super capacitor	Super capacitor

(1) More axes can be enabled by purchasing software codes

(2) EtherCAT registration also available by Touch Probe

SOFTWARE

Trio recommend that you use the latest version of *Motion Perfect 4* when using the MC664 (Minimum recommended version MPv4.3.1).

Software can be downloaded from www.triomotion.com















I/O CONNECTOR

The bottom 2 pins of the 30 way high density input connector are used to provide the 24V dc power to the MC664. A 24V dc, Class 2 transformer or power source must be provided.

The 2 pins above the 24V dc supply are to power the I/O 24 Volts.

 **THE MC664 IS GROUNDED VIA THE METAL CHASSIS. IT MUST BE INSTALLED ON AN UNPAINTED METAL PLATE OR DIN RAIL WHICH IS CONNECTED TO EARTH.**

 **THE MC464 I/O CONNECTOR DOES NOT FIT INTO THE MC664 / MC664-X MOTION COORDINATER.**

0V AIN		0V CAN/AIN
AIN0		CAN LOW
AIN1		CAN EARTH
WDOG+		CAN HIGH
WDOG-		24V CAN/AIN SUPPLY
10		I/O8
11		I/O9
12		I/O10
13		I/O11
14		I/O12
15		I/O13
16		I/O14
17		I/O15
0V I/O		24V I/O SUPPLY
0V SUPPLY		24V SUPPLY

RJ45 ETHERNET CONNECTOR (TOP)

A standard Ethernet connector is provided for use as the primary programming interface.

The Trio programming software, *Motion Perfect 4* and above, must be installed on a Windows based PC that is fitted with an Ethernet connection. The IP address is displayed on the MC664 display for a few seconds after power-up or when an Ethernet cable is plugged in.

RJ45 ETHERCAT CONNECTOR (BOTTOM)

EtherCAT master port for connection to Servo/Stepper drives and I/O devices via EtherCAT industry standard protocols.

Recommended screened cable for EtherCAT; Cat5 SF/UTP.



SERIAL CONNECTIONS (RS232) 8 WAY MINI-DIN

Pin	Function	Note
1	RS485 Data In A Rx+	Serial Port #2
2	RS485 Data In B Rx-	
3	RS232 Transmit	Serial Port #1
4	0V Serial	
5	RS232 Receive	Serial Port #1
6	Internal 5V	
7	RS485 Data Out Z Tx-	Serial Port #2
8	RS485 Data Out Y Tx+	

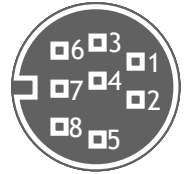

SYNC ENCODER CONNECTIONS (9 WAY D-TYPE)

Pin	Encoder	Absolute	Pulse & Direction
1	Enc. A	Clk +	Step +
2	Enc. /A	Clk -	Step -
3	Enc. B	N/C	Direction +
4	Enc. /B	N/C	Direction -
5	0V Encoder	0V Enc.	0V Stepper
6	Enc. Z	Data +	Enable -
7	Enc. /Z	Data -	Enable +
8	5V*	5V	5V*
9	Registration Input (5V)		

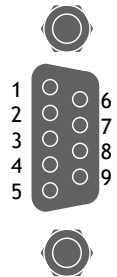

* 5V supply is limited to 150mA.

LCD DISPLAY

The model number, IP address and subnet mask of the MC664 are shown on the LCD display for a few seconds after power-up. The factory default IP address is 192.168.0.250. This can be changed using the ETHERNET or the `IP _ ADDRESS` command via *Motion Perfect*.



Display at start-up

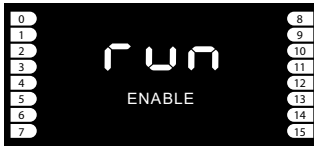

Display with WDOG on

ADDING EXPANSION MODULES

Unscrew the lower retaining fixing (A) using the supplied tool or a coin.

Remove the covers from the module (B).

Swing the expansion module (C) out from the rear and unclip from the front end.

Replacing the module is the reverse of the procedure.

Remove covers (E) before fitting full height expansion modules.

To access the recovery mode switch, insert screwdriver under the frontmost ventilation slot (D). See the Hardware Manual for details of recovery mode operation.

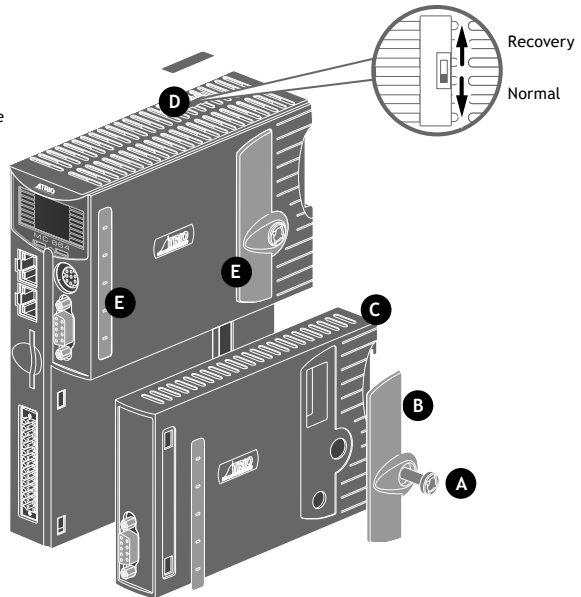

ERROR DISPLAY CODES

The information display area shows the IP address and subnet mask during power-up and whenever an Ethernet cable is first connected to the MC664. During operation, this display shows run, Off or Err to indicate the MC664 status. Below the main status display are the ERROR and ENABLE indicators.

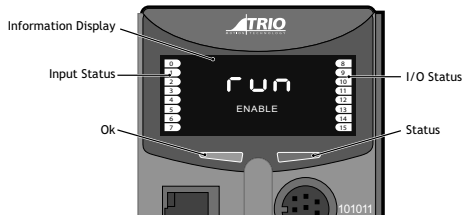

ERROR	An error has occurred (see Error Display Codes table below for details).
ENABLE	When illuminated, WDOG is ON.

A bank of 8 indicators at the left side shows the Digital Input States and a similar bank on the right shows the state of I/O8 to I/O15. The I/O displayed can be altered using the DISPLAY command.

Two LED's are provided to show the processor (OK) and system status.

Error Display Codes		
Unn	Unit error on slot nn	ie: EtherCAT failed to start
Ann	Axis error on axis aa	ie: following error exceeds limit
Caa	Configuration error on unit aa	ie: too many axes
Exx	System error	E00 - RAM error 8bit BB - RAM (VR) E01 - RAM error 16 bit BB - RAM (TABLE) E04 - VR/TABLE corrupt entry E05 - Invalid MC_CONFIG file E06 - Started in SAFE mode (system timeout) E07 - FPGA Error E08 - Flash memory error E09 - Processor Exception E10 - RFID chip access failed

MODULE ASSEMBLY

A maximum of 7 half height modules or 3 full height modules may be fitted to the MC664. A system may be made using any combination of half and full height modules providing that the full height modules are the last to be attached.

MODULE SLOT NUMBERS

SLOT Numbers are allocated by the system software in order, left to right, starting with the lower bus. Lower modules are allocated slots 0 to m, then the upper modules become slots m+1 to n. Finally the EtherCAT Port and the Sync Encoder Port are allocated slots n+1 and n+2.

* EtherCAT Port is disabled.

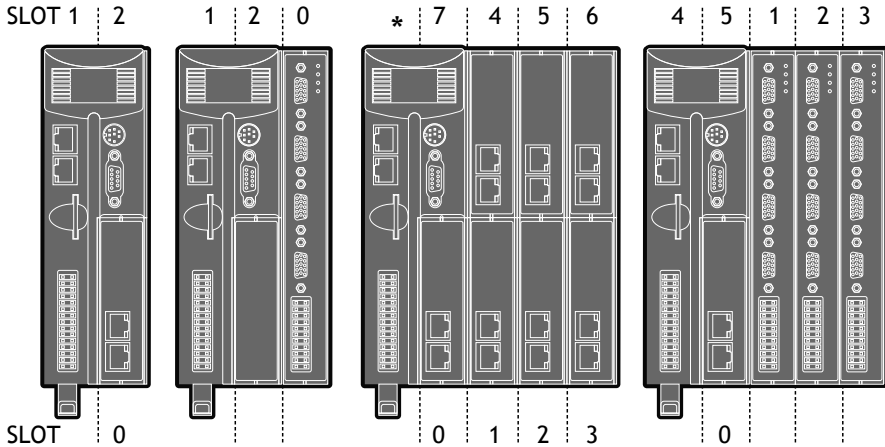

EXPANSION MODULE P871 - PANASONIC INTERFACE

REGISTRATION CONNECTOR

R0 - R7 registration inputs (24V).

R0V: registration common 0V return.

Registration inputs can be allocated to any axis by software.
Also available to software as general purpose inputs.



This pin out applies to module serial numbers P871-00011 and higher.

RJ45 CONNECTOR (TX)

100Mbps Panasonic "Realtime Express" transmit - connect to receive of first drive.

RJ45 CONNECTOR (RX)

100Mbps Panasonic "Realtime Express" receive - connect to transmit of last drive.

LED FUNCTIONS

LED	LED Colour	LED Function
ok	Green	ON=Module Initialised Okay
0	Red	ON=Module Error
1	Yellow	Status 1
2	Yellow	Status 2

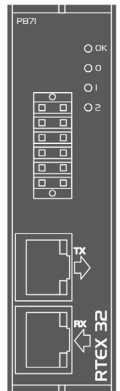
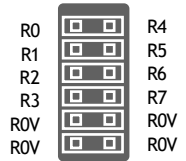

EXPANSION MODULE P872 - SERCOS INTERFACE

REGISTRATION CONNECTOR

R0 - R7: registration inputs (24V).
 R0V: registration common 0V return.

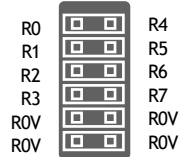

CONNECTOR (TX)

sercos fibre-optic transmit. (9mm FSMA)

CONNECTOR (RX)

sercos fibre-optic receive. (9mm FSMA)



LED FUNCTIONS

LED	LED Colour	LED Function
ok	Green	ON=Module Initialised Okay
0	Red	ON=Ring Open / Distorted
1	Yellow	sercos Phase
2	Yellow	sercos Phase
SERCOS PHASE	LED 1	LED 2
0	OFF	FLASH
1	OFF	ON
2	FLASH	OFF
3	ON	OFF
4	ON	ON

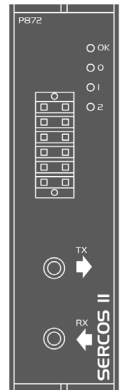

EXPANSION MODULE P873 - SLM INTERFACE

REGISTRATION CONNECTOR

R0 - R5:	registration inputs (24V).
0VR:	common 0V return.
0V PWR:	Power input for SLM system.
24V:	Power input for SLM system.

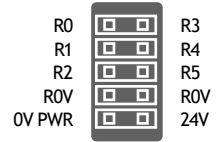

SLM CONNECTOR (15 WAY D-TYPE)

Pin	Upper D-Type	Lower D-Type
1	Com Axis 0	Com Axis 3
2	/Com Axis 0.	/Com Axis 3
3	Hardware Enable	Hardware Enable
4	0V Output	0V Output
5	24V Output	24V Output
6	Com Axis 1	Com Axis 4
7	/Com Axis 1	/Com Axis 4
8, 9, 10	No Connection	No Connection
11	24V Output	24V Output
12	0V Output	0V Output
13	Com Axis 2	Com Axis 5
14	/Com Axis 2	/Com Axis 5
15	Earth / Shield	Earth / Shield

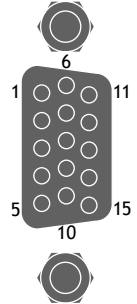

LED FUNCTIONS

LED	LED Colour	LED Function
ok	Green	ON=Module Initialised Okay
0	Red	ON=Module Error
1	Yellow	Status 1
2	Yellow	Status 2



EXPANSION MODULE P874 / P879 - FLEXIBLE AXIS INTERFACE

REGISTRATION CONNECTOR

V0 - V7:	Voltage outputs
R4/PS4 - R7/PS7:	Bidirectional registration / PSwitch
R0 - R3:	Registration Inputs
0V PWR:	Power Input
24V:	Power Input
V0V:	DAC common 0V return



4 axis version uses voltage outputs 0 - 3 only.

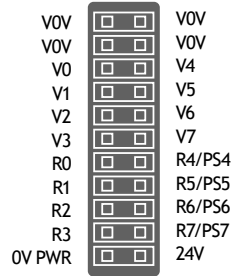

LED FUNCTIONS

LED	LED Colour	LED Function
ok	Green	ON=Module Initialised Okay
0	Red	ON=Module Error
1	Yellow	Status 1
2	Yellow	Status 2

ENCODER CONNECTOR (15 WAY D-TYPE)

Pin	Incremental Encoder	Absolute Encoder	Pulse & Direction
1	Enc. A n	Clock n	Step.+ n
2	Enc. /A n	/Clock n	Step.- n
3	Enc. B n	-----	Direction+ n
4	Enc. /B n	-----	Direction- n
5	0V Enc.	0V Enc.	0V Step.
6	Enc. Z n	Data n	Enable- n
7	Enc. /Z n	/Data n	Enable+ n
8	5V*	5V*	5V*
9	Enc. A n+4	Clock n+4	Step.+ n+4
10	Enc. /A n+4	/Clock n+4	Step.- n+4
11	Enc. B n+4	-----	Direction+ n+4
12	Enc. /B n+4	-----	Direction- n+4
13	Enc. Z n+4	Data n+4	Enable- n+4
14	Enc. /Z n+4	/Data n+4	Enable+ n+4
15	0V Enc.	0V Enc.	0V Enc.

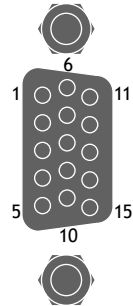

*5V supply is limited to 150mA per axis.

Connector	8 Axes (P874)	4 Axes (P879)
1	0 and 4	0
2	1 and 5	1
3	2 and 6	2
4	3 and 7	3

Absolute Encoder is only available on axes 4 - 7 on P874 and 2 - 3 on P879.

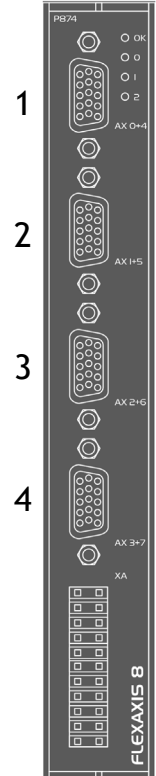

EXPANSION MODULE P875 - ANYBUS® INTERFACE

ANYBUS® FITTING

Push the Anybus® module (A) into the Trio Expansion Interface taking care to keep its base in contact with the PCB and align guide slots (B) with the connector rails inside. Ensure that the moulded hooks (C) on the lower front edge of the Anybus® module locate under the P875 PCB at the front.

When the module is flush with the face of the Trio Expansion Interface, tighten the two "Torx" head screws (D) to locate the two lugs (E) and secure the Anybus® module.

To remove the module, reverse this procedure.

The P875 supports Anubus CC M30 Modules.

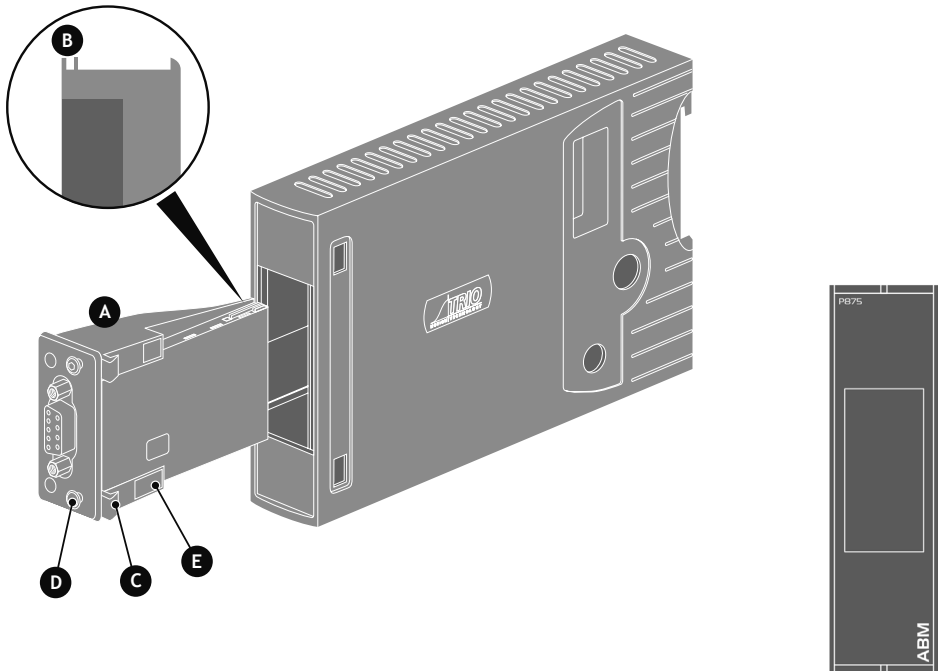

EXPANSION MODULE P876 - ETHERCAT INTERFACE

REGISTRATION CONNECTOR

R0 - R7: registration inputs (24V).

0V: registration common 0V return.

Registration inputs can be allocated to any axis by software.

Also available to software as general purpose inputs.

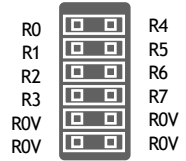

RJ45 CONNECTOR

100 base-T Ethernet master. Connect to IN of first slave.

LED FUNCTIONS

LED	LED Colour	LED Function
ok	Green	ON=Module Initialised Okay
0	Red	ON=Module Error SLOW FLASH=Not in Operational State QUICK FLASH=EtherCAT Error
1	Yellow	Status 1
2	Yellow	EtherCAT Activity

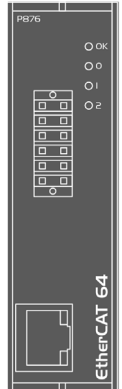

CHASSIS MOUNTING DIMENSIONS (LOOKING FROM REAR)

To mount the controller onto a back plane, remove the 2 mounting clips (included in box) and insert one at the top rear of the case, by fitting the small tab into the rectangular slot and fix with the M3 x 6mm screw provided.

The second clip fits to the bottom of the case rear. Line up the DIN rail lever with the hole and slot in the metal chassis, fit the clip into the slot and fix it with the M3 x 10mm screw.

- **ENSURE THAT THE VENTILATION SLOTS AT THE TOP AND BOTTOM OF THE MC664 ARE KEPT CLEAR TO ENSURE A FREE FLOW OF AIR THROUGH THE MODULE.**

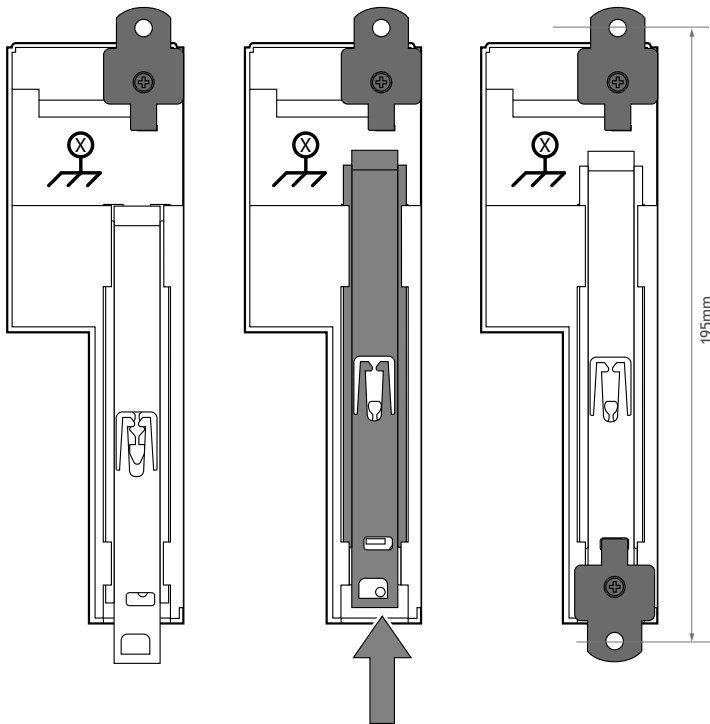

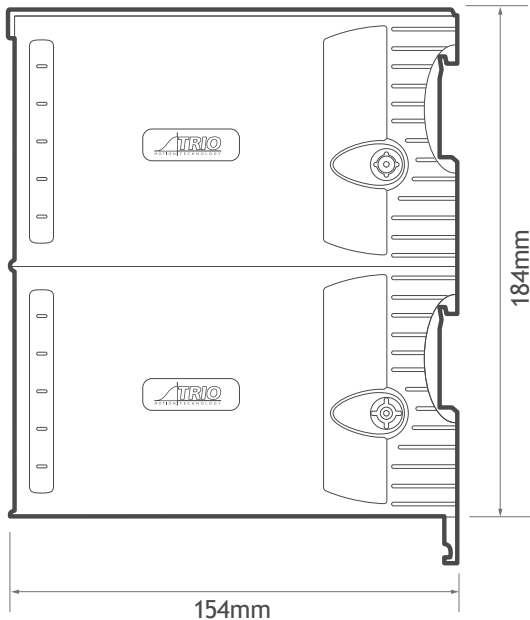
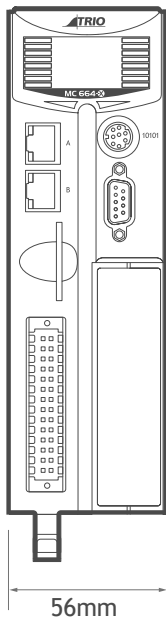

UK | USA | CHINA | INDIA
WWW.TRIOMOTION.COM
THE MOTION SPECIALIST

CAD data Drawings to aid packaging and mounting are available in various formats from the Trio web site. Products should be wired by qualified persons.
Specifications may change without notice. E & OE

Quick Start v3 September 2018